

MAX17242/MAX17243**3.5V–36V, 2A/3A, Synchronous Buck Converter with 15 μ A Quiescent Current and Reduced EMI****General Description**

The MAX17242/MAX17243 high-efficiency, synchronous step-down DC-DC converters with integrated MOSFETs operates over a 3.5V to 36V input voltage range, and can operate in drop-out condition by running at 99% duty cycle. The converters deliver up to 2A (MAX17242) and 3A (MAX17243) output current and generate fixed output voltages of 3.3V/5V, along with the ability to program the output voltage between 1V to 10V.

The devices use a current-mode-control architecture and can be operated in the pulse-width modulation (PWM) or pulse-frequency modulation (PFM) control schemes. PWM operation provides constant frequency operation at all loads, and is useful in applications sensitive to switching frequency. PFM operation disables negative inductor current and additionally skips pulses at light loads for high-efficiency operation. The low-resistance, on-chip MOSFETs ensure high efficiency at full load and simplify the layout.

The devices are available in a compact 20-pin (5mm x 5mm) TQFN package with exposed pad. These parts are rated for -40°C to +85°C operation.

Applications

- Distributed Supply Regulation
- Wall Transformer Regulation
- General-Purpose Point-of-Load

Ordering Information appears at end of data sheet.

Benefits and Features

- Eliminates External Components and Reduces Total Cost
 - No Schottky-Synchronous Operation for High Efficiency and Reduced Cost
 - Simple external RC Compensation for Stable Operation at Any Output Voltage
 - All-Ceramic Capacitor Solution: Ultra-Compact Layout with as Few as Eight External Components
 - PGOOD Output and High-Voltage EN Input Simplify Power Sequencing
- Reduces Number of DC-DC Converters to Stock
 - Pin Compatibility for 2A/3A Options
 - Fixed Output Voltage with $\pm 2\%$ Accuracy (5V/3.3V) or Externally Resistor Adjustable (1V to 10V) with $\pm 1\%$ FB Accuracy
 - 220kHz to 2.2MHz Adjustable Frequency with External Synchronization
- Reduces Power Dissipation
 - 93% Peak Efficiency
 - Shutdown Feature Blocks Current Flow from Input-to-Output or Vice-Versa
 - Less Than 5 μ A (typ) in Shutdown
 - Low 15 μ A (typ) Quiescent Current in Standby Mode
- Operates Reliably
 - 42V Input Voltage Transient Protection
 - Fixed 8ms Internal Software Start Reduces Input Inrush Current
 - Cycle-by-Cycle Current Limit, Thermal Shutdown with Automatic Recovery
 - Reduced EMI Emission with Spread-Spectrum Control

Typical Application Circuit/Block Diagram

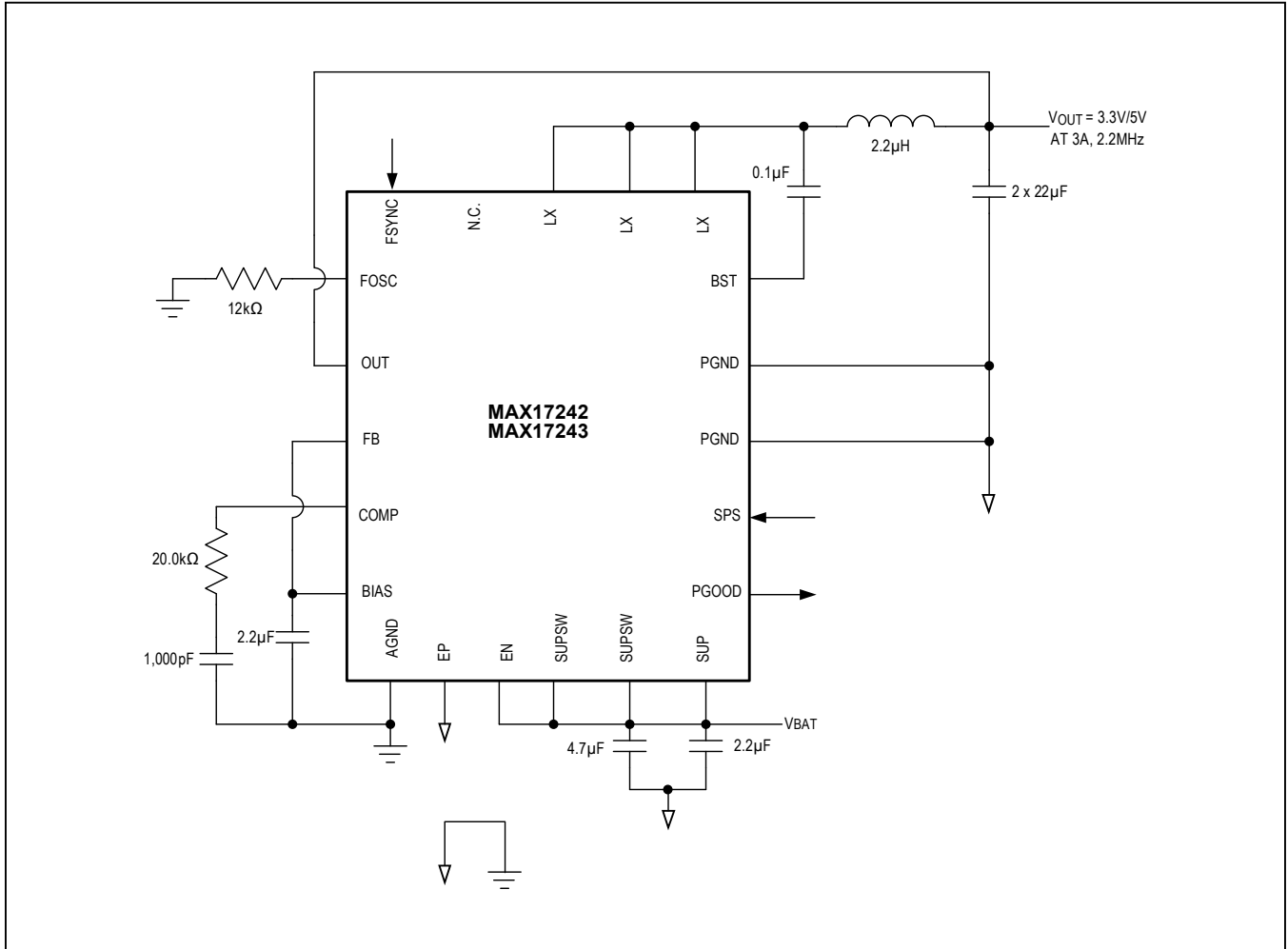

Absolute Maximum Ratings

SUP, SUPSW, LX, EN to PGND	-0.3V to +42V	Output Short-Circuit Duration	Continuous
SUP to SUPSW	-0.3V to +0.3V	Continuous Power Dissipation (T _A = +70°C)	20-Pin TQFN (derate 33.3mW/°C above +70°C) ..2666.7mW
BIAS to AGND	-0.3V to +6V	Operating Temperature Range	-40°C to +85°C
SPS, FOSC, COMP to AGND	-0.3V to (V _{BIAS} + 0.3V)	Junction Temperature	+150°C
FSYNC, PGOOD, FB to AGND	-0.3V to (V _{BIAS} + 0.3V)	Storage Temperature Range	-65°C to +150°C
OUT to PGND	-0.3V to +12V	Lead Temperature (soldering, 10s)	+300°C
BST to LX	-0.3V to +6V	Soldering Temperature (reflow)	+260°C
AGND to PGND	-0.3V to +0.3V		

Stresses beyond those listed under “Absolute Maximum Ratings” may cause permanent damage to the device. These are stress ratings only, and functional operation of the device at these or any other conditions beyond those indicated in the operational sections of the specifications is not implied. Exposure to absolute maximum rating conditions for extended periods may affect device reliability.

Package Thermal Characteristics (Note 1)

TQFN

Junction-to-Ambient Thermal Resistance (θ _{JA})	30°C/W
Junction-to-Case Thermal Resistance (θ _{JC})	2°C/W

Note 1: Package thermal resistances were obtained using the method described in JEDEC specification JESD51-7, using a four-layer board. For detailed information on package thermal considerations, refer to www.maximintegrated.com/thermal-tutorial.

Electrical Characteristics

V_{SUP} = V_{SUPSW} = 14V, V_{EN} = 14V, L₁ = 2.2µH, C_{IN} = 4.7µF, C_{OUT} = 44µF, C_{BIAS} = 2.2µF, C_{BST} = 0.1µF, R_{FOSC} = 12kΩ, T_A = T_J = -40°C to +85°C, unless otherwise noted. Typical values are at T_A = +25°C.

PARAMETER	SYMBOL	CONDITIONS	MIN	TYP	MAX	UNITS
Supply Voltage	V _{SUP} , V _{SUPSW}		3.5		36	V
Transient Event Supply Voltage	V _{SUP_LD}	t _{LD} < 1s			42	V
Supply Current (3.3V)	I _{SUP_STANDBY}	Standby mode, no load, V _{OUT} = 3.3V, V _{FSYNC} = 0V		15	30	µA
Supply Current (5V)	I _{SUP_STANDBY}	Standby mode, no load, V _{OUT} = 5V, V _{FSYNC} = 0V		20	35	µA
Shutdown Supply Current	I _{SHDN}	V _{EN} = 0V		5	10	µA
BIAS Regulator Voltage	V _{BIAS}	V _{SUP} = V _{SUPSW} = 6V to 42V. I _{BIAS} = 0 to 10mA	4.7	5	5.4	V
BIAS Undervoltage Lockout	V _{UVBIAS}	V _{BIAS} rising	2.9	3.15	3.4	V
BIAS Undervoltage-Lockout Hysteresis				400	500	mV
Thermal-Shutdown Threshold				175		°C
Thermal-Shutdown Threshold Hysteresis				15		°C
OUTPUT VOLTAGE						
PWM-Mode Output Voltage (Note 3)	V _{OUT_5V}	V _{FB} = V _{BIAS} , 6V < V _{SUPSW} < 36V, fixed-frequency mode	4.9	5	5.1	V
PFM-Mode Output Voltage (Note 4)	V _{OUT_PFM_5V}	No load, V _{FB} = V _{BIAS} , PFM mode	4.9	5	5.15	V
PWM-Mode Output Voltage (Note 3)	V _{OUT_3.3V}	V _{FB} = V _{BIAS} , 6V < V _{SUPSW} < 36V, fixed-frequency mode	3.23	3.3	3.37	V

Electrical Characteristics (continued)

$V_{SUP} = V_{SUPSW} = 14V$, $V_{EN} = 14V$, $L_1 = 2.2\mu H$, $C_{IN} = 4.7\mu F$, $C_{OUT} = 44\mu F$, $C_{BIAS} = 2.2\mu F$, $C_{BST} = 0.1\mu F$, $R_{FOSC} = 12k\Omega$, $T_A = T_J = -40^\circ C$ to $+85^\circ C$, unless otherwise noted. Typical values are at $T_A = +25^\circ C$.

PARAMETER	SYMBOL	CONDITIONS	MIN	TYP	MAX	UNITS
PFM-Mode Output Voltage (Note 4)	$V_{OUT_PFM_3.3V}$	No load, $V_{FB} = V_{BIAS}$, PFM mode	3.23	3.3	3.4	V
Load Regulation		$V_{FB} = V_{BIAS}$, $30mA < I_{LOAD} < 3A$		0.5		%
Line Regulation		$V_{FB} = V_{BIAS}$, $6V < V_{SUPSW} < 36V$		0.02		%/V
BST Input Current	I_{BST_ON}	High-side MOSFET on, $V_{BST} - V_{LX} = 5V$		1.5		mA
	I_{BST_OFF}	High-side MOSFET off, $V_{BST} - V_{LX} = 5V$		1.5		μA
LX Current Limit	I_{LX}	MAX17243	3.75	5	6.25	A
		MAX17242	2.5	3.33	4.16	
LX Rise Time		$V_{OUT} = 5V, 3.3V$		4		ns
Spread Spectrum		Spread spectrum enabled		FOSC $\pm 3\%$		
High-Side Switch On-Resistance	R_{ON_H}	$I_{LX} = 0.5A, V_{BIAS} = 5V$		60	140	m Ω
High-Side Switch Leakage Current		High-side MOSFET off, $V_{SUP} = 36V$, $V_{LX} = 0V, T_A = +25^\circ C$		1	5	μA
Low-Side Switch On-Resistance	R_{ON_L}	$I_{LX} = 0.5A, V_{BIAS} = 5V$		35	70	m Ω
Low-Side Switch Leakage Current		Low-side MOSFET off, $V_{SUP} = 36V$, $V_{LX} = 36V, T_A = +25^\circ C$		1	5	μA
FB Input Current	I_{FB}	$T_A = +25^\circ C$		20	100	nA
FB Regulation Voltage	V_{FB}	FB connected to an external resistive divider, $6V < V_{SUPSW} < 36V$	0.99	1	1.01	V
FB Line Regulation	ΔV_{LINE}	$6V < V_{SUPSW} < 36V$		0.02		%/V
Transconductance (from FB to COMP)	gm	$V_{FB} = 1V, V_{BIAS} = 5V$		700		μS
Minimum On-Time	t_{ON_MIN}				80	ns
Maximum Duty Cycle	DC_{MAX}			98	99	%
Oscillator Frequency		$R_{FOSC} = 73.2k\Omega$		400		kHz
		$R_{FOSC} = 12k\Omega$	2.0	2.2	2.4	MHz
SYNC, EN, AND SPS LOGIC THRESHOLDS						
External Input Clock Acquisition time	t_{FSYNC}			1		Cycle
External Input Clock Frequency		$R_{FOSC} = 12k\Omega$ (Note 5)	1.8		2.6	MHz
External Input Clock High Threshold	V_{FSYNC_HI}	V_{FSYNC} rising	1.4			V
External Input Clock Low Threshold	V_{FSYNC_LO}	V_{FSYNC} falling			0.4	V
FSYNC Leakage Current		$T_A = +25^\circ C$			1	μA
Soft-Start Time	t_{SS}		5.6	8	12	ms

Electrical Characteristics (continued)

$V_{SUP} = V_{SUPSW} = 14V$, $V_{EN} = 14V$, $L1 = 2.2\mu H$, $C_{IN} = 4.7\mu F$, $C_{OUT} = 44\mu F$, $C_{BIAS} = 2.2\mu F$, $C_{BST} = 0.1\mu F$, $R_{FOSC} = 12k\Omega$, $T_A = T_J = -40^\circ C$ to $+85^\circ C$, unless otherwise noted. Typical values are at $T_A = +25^\circ C$.

PARAMETER	SYMBOL	CONDITIONS	MIN	TYP	MAX	UNITS
Enable Input High Threshold	V_{EN_HI}		2.4			V
Enable Input Low Threshold	V_{EN_LO}				0.6	V
Enable Threshold-Voltage Hysteresis	V_{EN_HYS}			0.2		V
Enable Input Current	I_{EN}	$T_A = +25^\circ C$		0.1	1	µA
Spread-Spectrum Input High Threshold	V_{SPS_HI}		2.0			V
Spread-Spectrum Input Low Threshold	V_{SPS_LO}				0.4	V
Spread-Spectrum Input Current	I_{SPS}	$T_A = +25^\circ C$		0.1	1	µA
POWER-GOOD AND OVERVOLTAGE-PROTECTION THRESHOLDS						
PGOOD Switching Level	V_{RISING}	V_{FB} rising, $V_{PGOOD} = \text{high}$	93	95	97	% V_{FB}
	$V_{FALLING}$	V_{FB} falling, $V_{PGOOD} = \text{low}$	90	92.5	95	
PGOOD Debounce Time				25		µs
PGOOD Output Low Voltage		$I_{SINK} = 5mA$			0.4	V
PGOOD Leakage Current		V_{OUT} in regulation, $T_A = +25^\circ C$			1	µA
Overvoltage Protection Threshold		V_{OUT} rising (Monitor FB pin)		107		%
		V_{OUT} falling (Monitor FB pin)		104		

Note 2: Limits are 100% production tested at $T_A = +25^\circ C$. Limits over the operating temperature range are guaranteed by design.

Note 3: Device not in dropout condition.

Note 4: Guaranteed by design; not production tested.

Note 5: Contact the factory for SYNC frequency outside the specified range.

Typical Operating Characteristics

($V_{SUP} = V_{SUPSW} = 14V$, $V_{EN} = 14V$, $V_{OUT} = 5V$, $V_{FSYNC} = 0V$, $R_{FOSC} = 12k\Omega$, $T_A = +25^\circ C$, unless otherwise noted.)

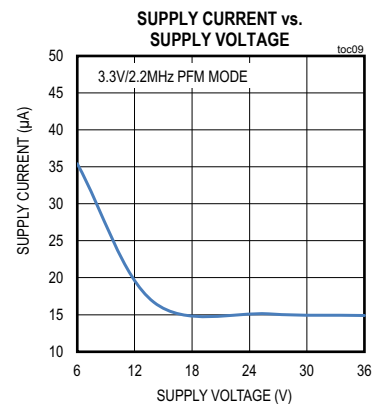
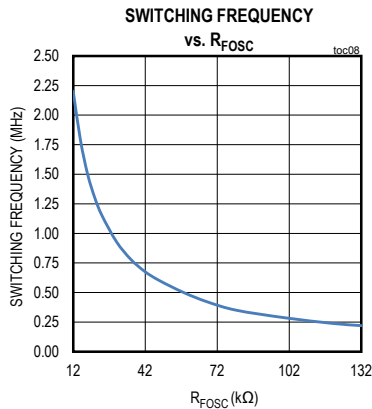
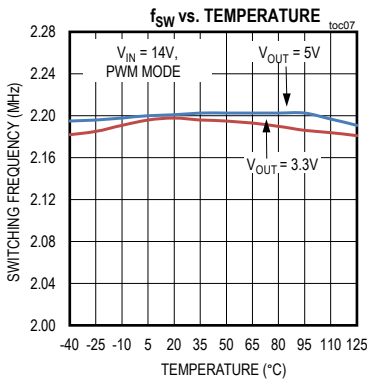
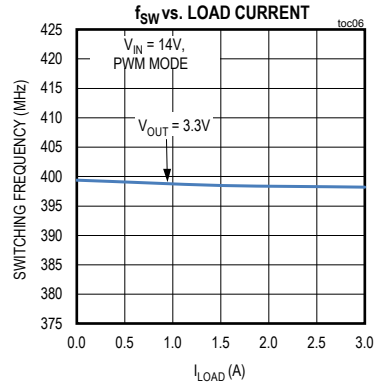
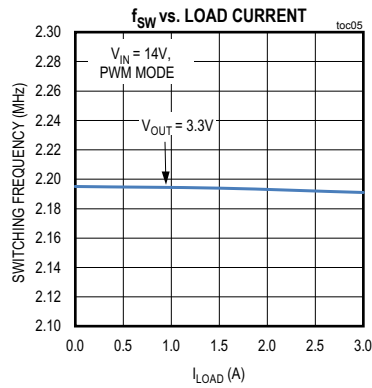
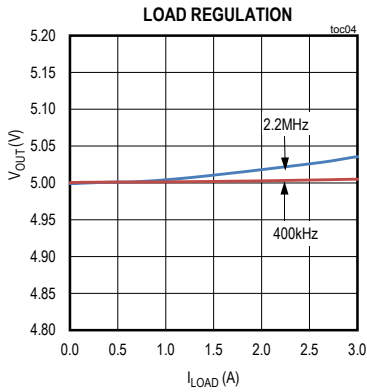
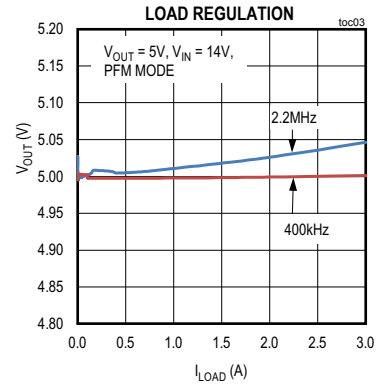
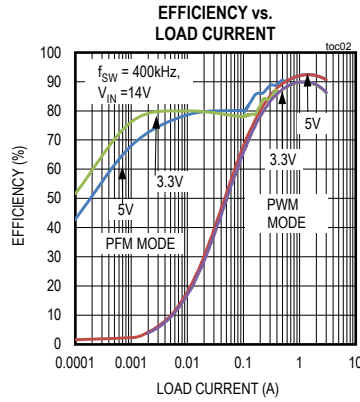
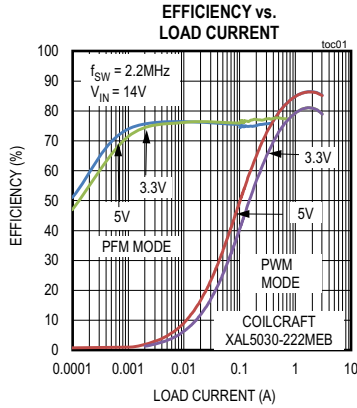

Typical Operating Characteristics (continued)

($V_{SUP} = V_{SUPSW} = 14V$, $V_{EN} = 14V$, $V_{OUT} = 5V$, $V_{FSYNC} = 0V$, $R_{FOSC} = 12k\Omega$, $T_A = +25^\circ C$, unless otherwise noted.)

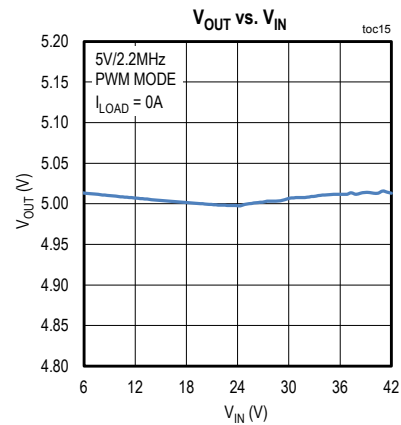
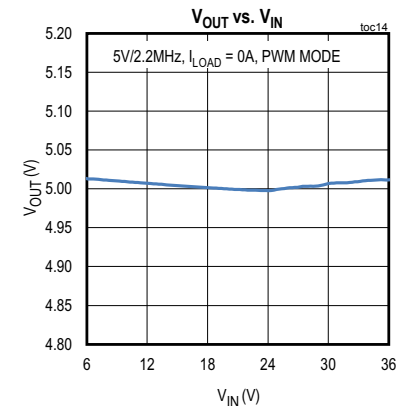
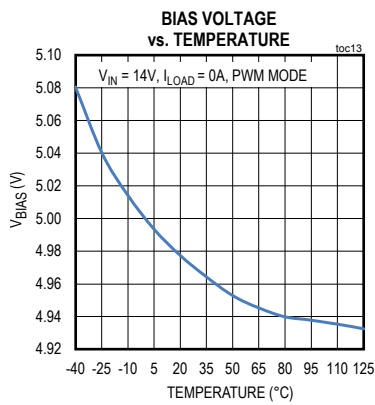
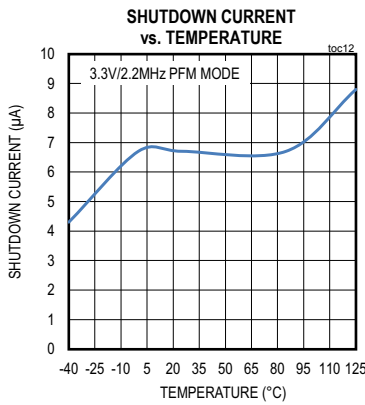
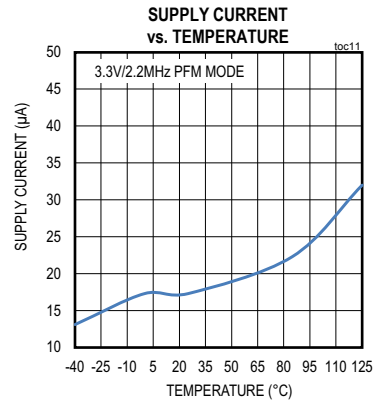
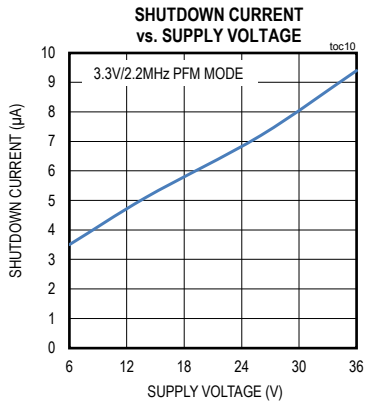

Typical Operating Characteristics (continued)

($V_{SUP} = V_{SUPSW} = 14V$, $V_{EN} = 14V$, $V_{OUT} = 5V$, $V_{FSYNC} = 0V$, $R_{FOSC} = 12k\Omega$, $T_A = +25^\circ C$, unless otherwise noted.)

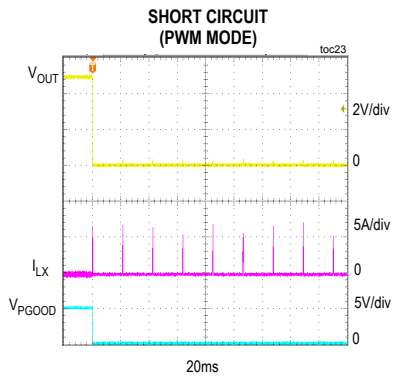
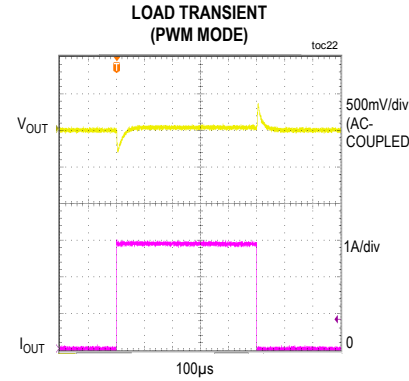
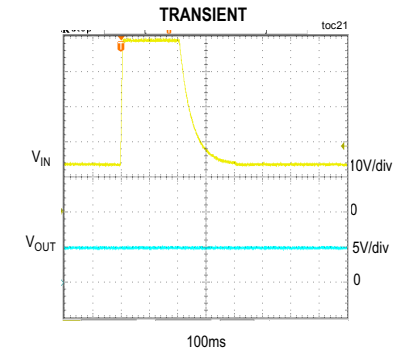
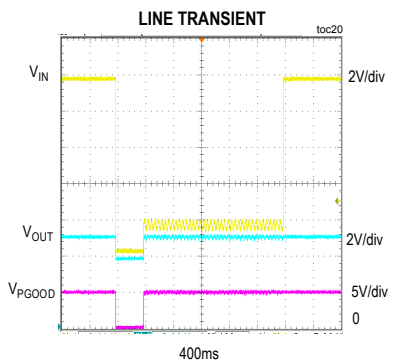
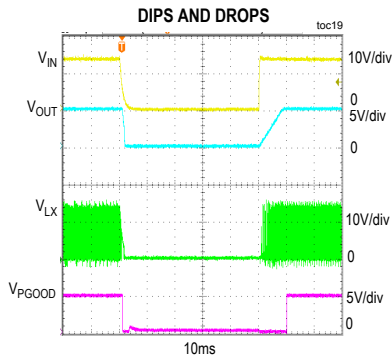
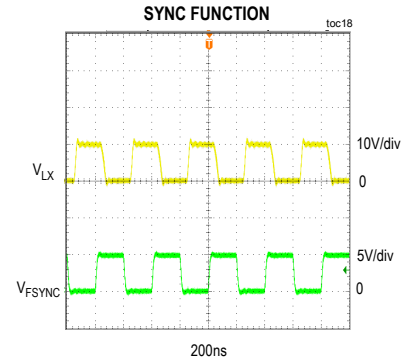
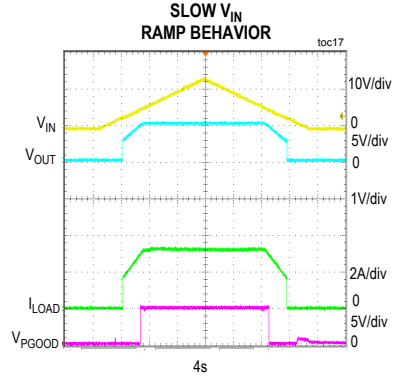
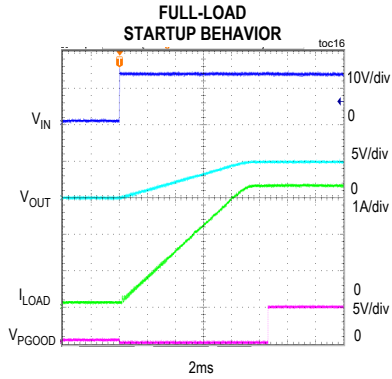

Pin Configuration

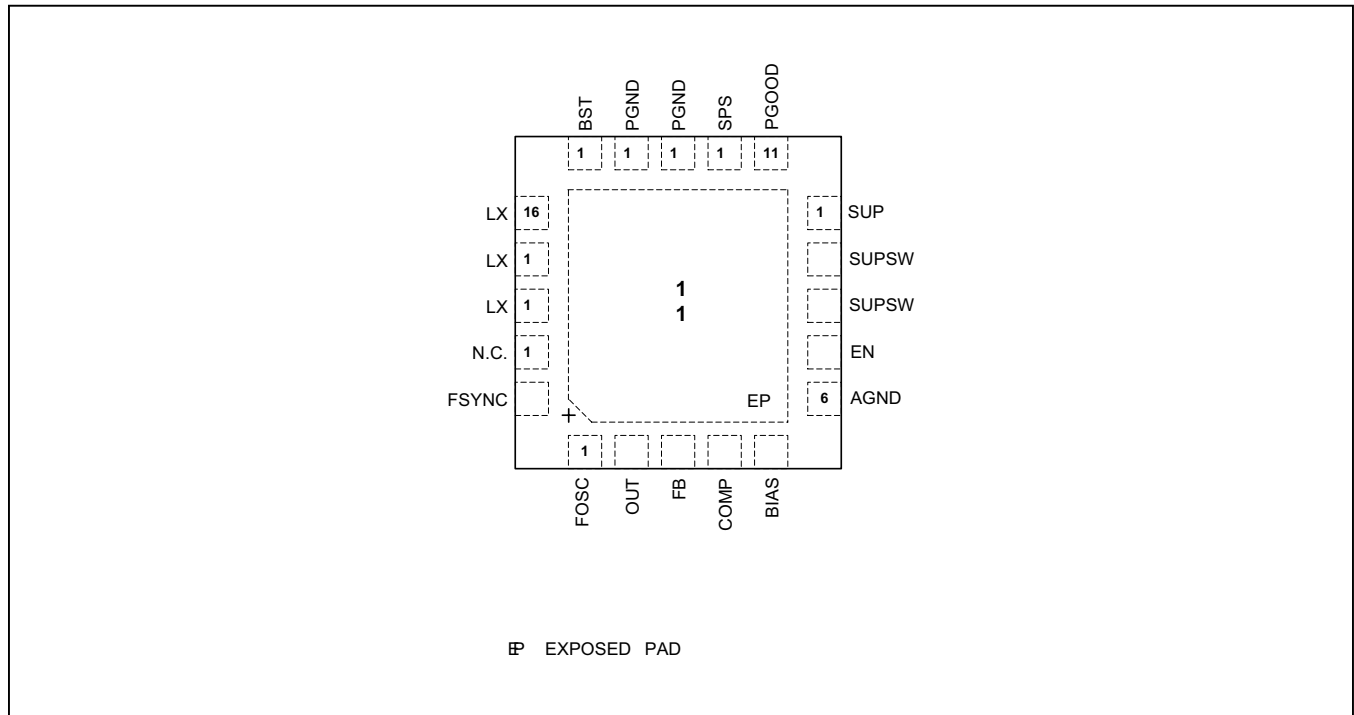

Pin Description

PIN	NAME	FUNCTION
1	FOSC	Resistor-Programmable Switching Frequency Setting Control Input. Connect a resistor from FOSC to AGND to set the switching frequency.
2	OUT	Switching Regulator Output. OUT also provides power to the internal circuitry when the output voltage of the converter is set between 3V to 5V during standby mode.
3	FB	Feedback Input. Connect an external resistive divider from OUT to FB and AGND to set the output voltage. Connect to BIAS to set the output voltage to 5V or 3.3V.
4	COMP	Error Amplifier Output. Connect an RC network from COMP to AGND for stable operation. See the <i>Compensation Network</i> section for more details.
5	BIAS	Linear Regulator Output. BIAS powers up the internal circuitry. Bypass with a minimum of 2.2µF ceramic capacitor to AGND.
6	AGND	Analog Ground
7	EN	SUP Voltage-Compatible Enable Input. Drive EN low to PGND to disable the devices. Drive EN high to enable the devices.
8, 9	SUPSW	Internal High-Side Switch Supply Input. SUPSW provides power to the internal switch. Bypass SUPSW to PGND with a 0.1µF and 4.7µF ceramic capacitors.
10	SUP	Voltage Supply Input. SUP powers up the internal linear regulator. Bypass SUP to PGND with a 2.2µF ceramic capacitor.
11	PGOOD	Open-Drain, PGOOD Output. PGOOD asserts when V_{OUT} is above 95% regulation point. PGOOD goes low to AGND when V_{OUT} is below 92% regulation point.

Pin Description (continued)

PIN	NAME	FUNCTION
12	SPS	Spread-Spectrum Pin. Pull high for spread spectrum on and low to AGND for spread spectrum off.
13,14	PGND	Power Ground
15	BST	High-Side Driver Supply. Connect a 0.1 μ F capacitor between LX and BST for proper operation.
16–18	LX	Inductor Switching Node
19	N.C.	No Connection
20	FSYNC	Synchronization Input. The devices synchronize to an external signal applied to FSYNC. Connect FSYNC to AGND to enable PFM mode operation. Connect to BIAS or to an external clock to enable fixed-frequency, forced-PWM mode operation.
—	EP	Exposed Pad. Connect EP to a large-area contiguous copper ground plane for effective power dissipation. Do not use as the only IC ground connection. EP must be connected to PGND.

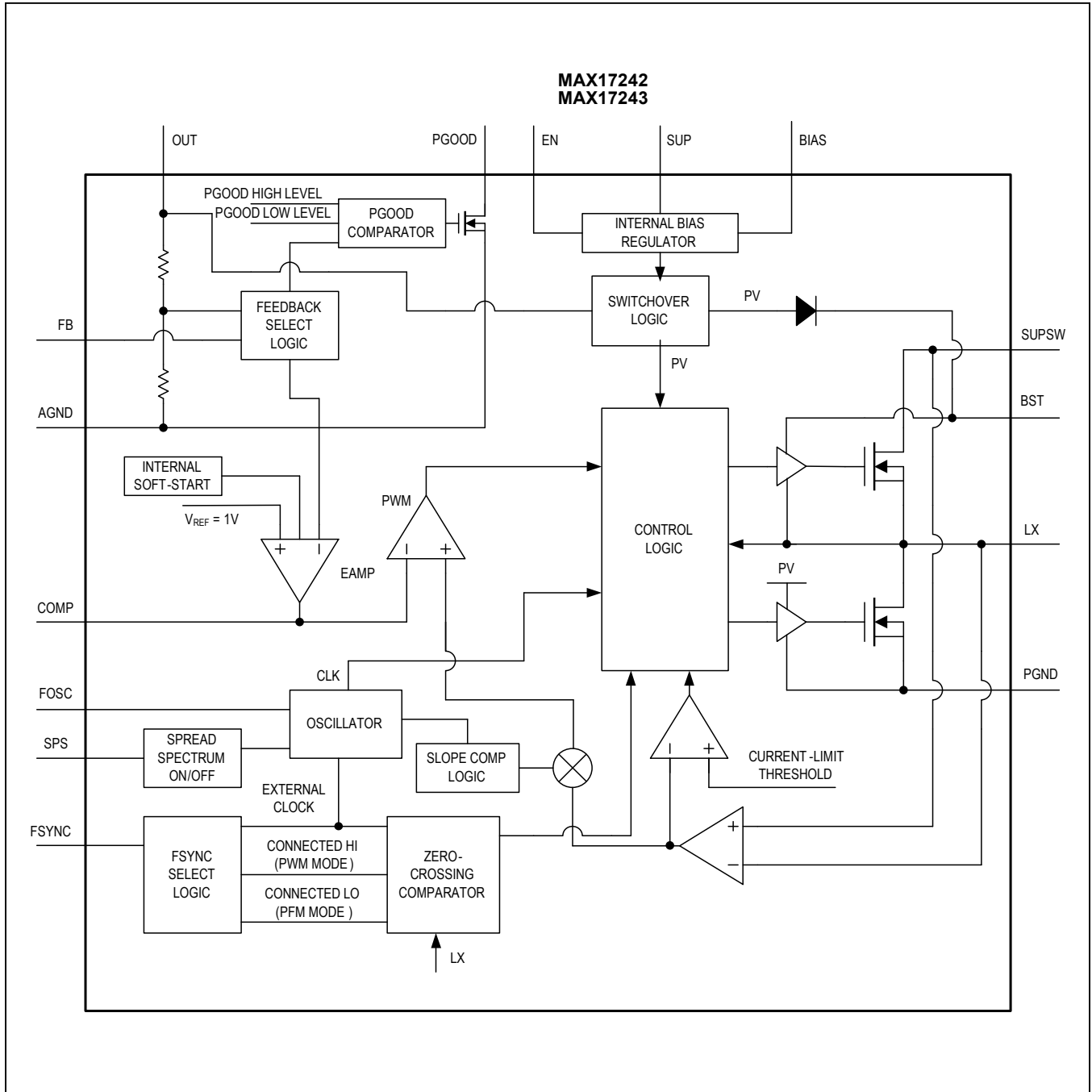

Figure 1. Internal Block Diagram

Detailed Description

The MAX17242/MAX17243 are 2A/3A current-mode step-down converters with integrated high-side and low-side MOSFETs. The low-side MOSFET enables fixed-frequency, forced-PWM operation in light-load applications. The devices operate with input voltages from 3.5V to 36V while using only 15µA quiescent current at no load. The switching frequency is resistor programmable from 220kHz to 2.2MHz and can be synchronized to an external clock. The devices' output voltage is available as 5V/3.3V fixed or adjustable from 1V to 10V. The wide input voltage range, along with its ability to operate at 99% duty cycle during undervoltage transients, makes the devices ideal for many applications.

In light-load applications, a logic input (FSYNC) allows the devices to operate either in PFM mode for reduced current consumption, or fixed-frequency, forced-PWM mode to eliminate frequency variation and help minimize EMI. Protection features include cycle-by-cycle current limit, and thermal shutdown with automatic recovery.

Wide Input Voltage Range

The devices include two separate supply inputs (SUP and SUPSW) specified for a wide 3.5V to 36V input voltage range. V_{SUP} provides power to the device and V_{SUPSW} provides power to the internal switch. Often in a system, severe transient conditions can cause the voltage at SUP and SUPSW pins to drop below the programmed output voltage. In a system where severe transient conditions can cause the voltage at the SUP and SUPSW pins to drop below the programmed output voltage. Under such conditions, the devices operate in a high duty-cycle mode to facilitate minimum dropout from input to output.

Maximum Duty-Cycle Operation

The devices have a maximum duty cycle of 98% (typ). The IC monitors the off time (time for which the low-side FET is on) in both PWM and PFM modes during every switching cycle every switching cycle. Once the off time of 100ns (typ) is detected continuously for 12µs, the low-side FET is forced on for 150ns (typ) every 12µs. The input voltage at which the devices enter dropout changes depending on the input voltage, output voltage, switching frequency, load current, and the efficiency of the design.

The input voltage at which the devices enter dropout can be approximated as:

$$V_{SUP} = \frac{V_{OUT} + (I_{OUT} \times R_{ON_H})}{0.98}$$

Note: The equation above does not take into account the efficiency and switching frequency but is a good first-order approximation. Use the R_{ON_H} number from the max column in the [Electrical Characteristics](#) table.

Linear Regulator Output (BIAS)

The devices include a 5V linear regulator (V_{BIAS}) that provides power to the internal circuit blocks. Connect a 2.2µF ceramic capacitor from BIAS to AGND.

Power-Good Output (PGOOD)

The devices feature an open-drain power-good output (PGOOD). PGOOD asserts when V_{OUT} rises above 95% of its regulation voltage. PGOOD deasserts when V_{OUT} drops below 92.5% of its regulation voltage. Connect PGOOD to BIAS with a 10kΩ resistor to AGND.

Synchronization Input (FSYNC)

FSYNC is a logic-level input useful for operating-mode selection and frequency control. Connecting FSYNC to BIAS or to an external clock enables fixed-frequency, forced-PWM operation. Connecting FSYNC to AGND enables PFM-mode operation.

The external clock frequency at FSYNC can be higher or lower than the internal clock by 20%. If the external clock frequency is greater than 120% of the internal clock, contact the factory applications team to verify the design. The devices synchronize to the external clock in two cycles. When the external clock signal at FSYNC is absent for more than two clock cycles, the devices use the internal clock.

System Enable (EN)

An enable control input (EN) activates the devices from their low-power shutdown mode. EN is rated up to 42V, allowing direct connection to SUP or through a resistor divider to set the desired input undervoltage-lockout threshold.

EN turns on the internal regulator. Once V_{BIAS} is above the internal lockout threshold, $V_{UVBIAS} = 3.15V$ (typ), the converter activates and the output voltage ramps up within 8ms.

A logic-low to PGND at EN shuts down the device. During shutdown, the internal linear regulator and gate drivers turn off. Shutdown is the lowest power state and reduces the quiescent current to 5µA (typ). Drive EN high to bring the devices out of shutdown.

Spread-Spectrum Option

The spread spectrum can be enabled on the device using a pin. When the SPS pin is pulled high the spread spectrum is enabled and the operating frequency is varied $\pm 3\%$ centered on FOSC. The modulation signal is a triangular wave with a period of 110µs at 2.2MHz. Therefore, FOSC ramps down 3% and back to 2.2MHz in 110µs and also ramps up 3% and back to 2.2MHz in 110µs. The cycle repeats.

For operations at FOSC values other than 2.2MHz, the modulation signal scales proportionally (e.g., at 400kHz, the 110µs modulation period increases to 110µs \times 2.2MHz/0.4MHz = 550µs).

The internal spread spectrum is disabled if the devices are synchronized to an external clock. However, the devices do not filter the input clock on the FSYNC pin and pass any modulation (including spread spectrum) present on the driving external clock. Drive the SPS pin low to AGND to disable spread spectrum.

Internal Oscillator (FOSC)

The switching frequency (f_{SW}) is set by a resistor (R_{FOSC}) connected from FOSC to AGND. For example, a 400kHz switching frequency is set with $R_{FOSC} = 73.2\text{k}\Omega$. Higher frequencies allow designs with lower inductor values and less output capacitance. Consequently, peak currents and I^2R losses are lower at higher switching frequencies, but core losses, gate-charge currents, and switching losses increase. See [Typical Operating Characteristics](#) section.

Overtemperature Protection

Thermal overload protection limits the total power dissipation in the device. When the junction temperature exceeds 175°C (typ), an internal thermal sensor shuts down the internal bias regulator and the step-down converter, allowing the IC to cool. The thermal sensor turns on the IC again after the junction temperature cools by 15°C.

Applications Information

Setting the Output Voltage

Connect FB to BIAS for a fixed +5V/3.3V output voltage. See [Ordering Information](#). To set the output to other voltages between 1V and 10V, connect a resistive divider from output (OUT) to FB to AGND (Figure 2). Select R_{FB2} (FB to AGND resistor) less than or equal to 500kΩ. Calculate R_{FB1} (OUT to FB resistor) with the following equation:

$$R_{FB1} = R_{FB2} \left[\left(\frac{V_{OUT}}{V_{FB}} \right) - 1 \right]$$

where $V_{FB} = 1\text{V}$ (see the [Electrical Characteristics](#) table).

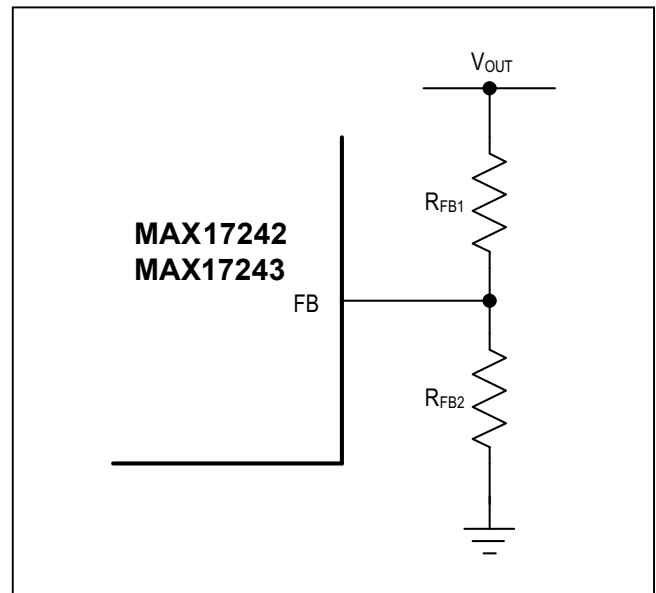

Figure 2. Adjustable Output-Voltage Setting

Forced-PWM and PFM Modes

In PWM mode of operation, the devices switch at a constant frequency with variable on-time. In PFM mode of operation, the converter's switching frequency is load dependent. At higher load current, the switching frequency does not change and the operating mode is similar to the PWM mode. PFM mode helps improve efficiency in light-load applications by allowing the converters to turn on the high-side switch only when the output voltage falls below a set threshold. As such, the converters do not switch MOSFETs on and off as often as in the PWM mode. Consequently, the gate charge and switching losses are much lower in PFM mode. The operation mode of the device is set by FSYNC pin.

Inductor Selection

Three key inductor parameters must be specified for operation with the devices: inductance value (L), inductor saturation current (I_{SAT}), and DC resistance (R_{DCR}). To select inductor value, the ratio of inductor peak-to-peak AC current to DC average current (LIR) must be selected first. A good compromise between size and loss is a 30% peak-to-peak ripple current to average-current ratio (LIR = 0.3). The switching frequency, input voltage, output voltage, and selected LIR then determine the inductor value as follows:

$$L = \frac{(V_{SUP} - V_{OUT}) \times V_{OUT}}{V_{SUP} \times f_{SW} \times I_{OUT} \times LIR}$$

where V_{SUP} , V_{OUT} , and I_{OUT} are typical values (so that efficiency is optimum for typical conditions). The switching frequency is set by R_{FOSC} (see TOC 8 in the [Typical Operating Characteristics](#) section).

Input Capacitor

The input filter capacitor reduces peak currents drawn from the power source and reduces noise and voltage ripple on the input caused by the circuit's switching.

The input capacitor RMS current requirement (I_{RMS}) is defined by the following equation:

$$I_{RMS} = I_{LOAD(MAX)} \times \frac{\sqrt{V_{OUT} \times (V_{SUP} - V_{OUT})}}{V_{SUP}}$$

I_{RMS} has a maximum value when the input voltage equals twice the output voltage:

$$V_{SUP} = 2 \times V_{OUT}$$

therefore:

$$I_{RMS} = \frac{I_{LOAD(MAX)}}{V_{SUP}}$$

Choose an input capacitor that exhibits less than +10°C self-heating temperature rise at the RMS input current for optimal long-term reliability.

The input-voltage ripple is comprised of ΔV_Q (caused by the capacitor discharge) and ΔV_{ESR} (caused by the ESR of the capacitor). Use low-ESR ceramic capacitors with high ripple-current capability at the input. Assume the contribution from the ESR and capacitor discharge equal to 50%. Calculate the input capacitance and ESR required for a specified input voltage ripple using the following equations:

$$ESR_{IN} = \frac{\Delta V_{ESR}}{I_{OUT} + \frac{\Delta I_L}{2}}$$

where:

$$\Delta I_L = \frac{(V_{SUP} - V_{OUT}) \times V_{OUT}}{V_{SUP} \times f_{SW} \times L}$$

and:

$$C_{IN} = \frac{I_{OUT} \times D(1-D)}{\Delta V_Q \times f_{SW}}$$

$$D = \frac{V_{OUT}}{V_{SUPSW}}$$

where: I_{OUT} is the maximum output current and D is the duty cycle.

Output Capacitor

The output filter capacitor must have low enough equivalent series resistance (ESR) to meet output-ripple and load-transient requirements. The output capacitance must be high enough to absorb the inductor energy while transitioning from full-load to no-load conditions without tripping the overvoltage-fault protection. When using high-capacitance, low-ESR capacitors, the filter capacitor's ESR dominates the output-voltage ripple, so the size of the output capacitor depends on the maximum ESR required to meet the output-voltage ripple ($V_{RIPPLE(P-P)}$) specifications:

$$V_{RIPPLE(P-P)} = ESR \times I_{LOAD(MAX)} \times LIR$$

The actual capacitance value required relates to the physical size needed to achieve low ESR, as well as to the chemistry of the capacitor technology. Thus, the capacitor is usually selected by ESR and voltage rating rather than by capacitance value.

When using low-capacity filter capacitors, such as ceramic capacitors, size is usually determined by the capacity needed to prevent voltage droop and voltage rise from causing problems during load transients. Generally, once enough capacitance is added to meet the overshoot requirement, undershoot at the rising load edge is no longer a problem. However, low-capacity filter capacitors typically have high-ESR zeros that can affect the overall stability.

Compensation Network

The devices use an internal transconductance error amplifier with its inverting input and its output available to the user for external frequency compensation. The output capacitor and compensation network determine the loop stability. The inductor and the output capacitor are chosen based on performance, size, and cost. Additionally, the compensation network optimizes the control-loop stability.

The converter uses a current-mode-control scheme that regulates the output voltage by forcing the required current through the external inductor. The devices use the voltage drop across the high-side MOSFET to sense inductor current. Current-mode control eliminates the double pole in the feedback loop caused by the inductor and output capacitor, resulting in a smaller phase shift and requiring less elaborate error-amplifier compensation than voltage-mode control. Only a simple single series resistor (R_C) and capacitor (C_C) are required to have a stable, high-bandwidth loop in applications where ceramic capacitors are used for output filtering (see Figure 3). For other types of capacitors, due to the higher capacitance and ESR, the frequency of the zero created by the capacitance and ESR is lower than the desired closed-loop crossover frequency. To stabilize a nonceramic output-capacitor loop, add another compensation capacitor (C_F) from COMP to ground to cancel this ESR zero.

The basic regulator loop is modeled as a power modulator, output feedback divider, and an error amplifier. The power modulator has a DC gain set by $g_m \times R_{LOAD}$, with a pole and zero pair set by R_{LOAD} , the output capacitor (C_{OUT}), and its ESR. The following equations help to approximate the value for the gain of the power modulator ($GAIN_{MOD(dc)}$), neglecting the effect of the ramp stabilization. Ramp stabilization is necessary when the duty cycle is above 50% and is internally done for the devices:

$$GAIN_{MOD(dc)} = g_{mc} \times R_{LOAD}$$

where $R_{LOAD} = V_{OUT}/I_{OUT(MAX)}$ in Ω and $g_{mc} = 3S$.

In a current-mode step-down converter, the output capacitor, its ESR, and the load resistance introduce a pole at the following frequency:

$$f_{pMOD} = \frac{1}{2\pi \times C_{OUT} \times R_{LOAD}}$$

The output capacitor and its ESR also introduce a zero at:

$$f_{zMOD} = \frac{1}{2\pi \times ESR \times C_{OUT}}$$

When C_{OUT} is composed of “n” identical capacitors in parallel, the resulting $C_{OUT} = n \times C_{OUT(EACH)}$, and $ESR = ESR(EACH)/n$. Note that the capacitor zero for a parallel combination of alike capacitors is the same as for an individual capacitor.

The feedback voltage-divider has a gain of $GAIN_{FB} = V_{FB}/V_{OUT}$, where V_{FB} is 1V (typ).

The transconductance error amplifier has a DC gain of $GAIN_{EA(DC)} = g_{m_EA} \times R_{OUT_EA}$, where g_{m_EA} is the error amplifier transconductance, which is 700µS (typ), and R_{OUT_EA} is the output resistance of the error amplifier (50M Ω).

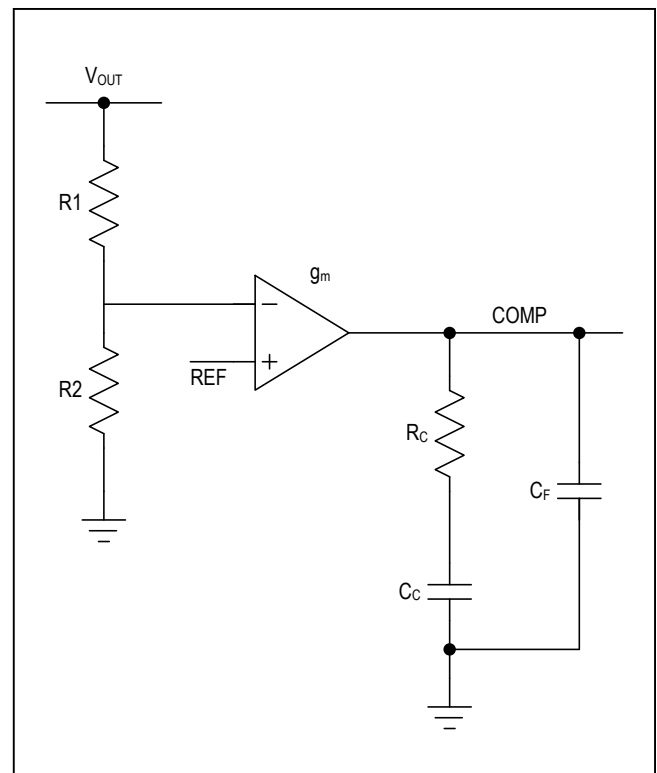

Figure 3. Compensation Network

A dominant pole (f_{dpEA}) is set by the compensation capacitor (C_C) and the amplifier output resistance ($R_{OUT,EA}$). A zero (f_{zEA}) is set by the compensation resistor (R_C) and the compensation capacitor (C_C). There is an optional pole (f_{pEA}) set by C_F and R_C to cancel the output capacitor ESR zero if it occurs near the crossover frequency (f_C , where the loop gain equals 1 (0dB)). Thus:

$$f_{zEA} = \frac{1}{2\pi \times C_C \times R_C}$$

$$f_{pdEA} = \frac{1}{2\pi \times C_C \times (R_{OUT,EA} + R_C)}$$

$$f_{pEA} = \frac{1}{2\pi \times C_F \times R_C}$$

The loop-gain crossover frequency (f_C) should be set below 1/5 of the switching frequency and much higher than the power-modulator pole (f_{pMOD}):

$$f_{pMOD} \ll f_C \leq \frac{f_{SW}}{5}$$

The total loop gain as the product of the modulator gain, the feedback voltage divider gain, and the error amplifier gain at f_C should be equal to 1. So:

$$GAIN_{MOD}(f_C) \times \frac{V_{FB}}{V_{OUT}} \times GAIN_{EA}(f_C) = 1$$

For the case where f_{zMOD} is greater than f_C :

$$GAIN_{EA}(f_C) = g_{m,EA} \times R_C$$

Therefore:

$$GAIN_{MOD}(f_C) \times \frac{V_{FB}}{V_{OUT}} \times g_{m,EA} \times R_C = 1$$

Solving for R_C :

$$R_C = \frac{V_{OUT}}{g_{m,EA} \times V_{FB} \times GAIN_{MOD}(f_C)}$$

Set the error-amplifier compensation zero formed by R_C and C_C (f_{zEA}) at the f_{pMOD} . Calculate the value of C_C as follows:

$$C_C = \frac{1}{2\pi \times f_{pMOD} \times R_C}$$

If f_{zMOD} is less than $5 \times f_C$, add a second capacitor (C_F) from COMP to GND and set the compensation pole formed by R_C and C_F (f_{pEA}) at the f_{zMOD} . Calculate the value of C_F as follows:

$$C_F = \frac{1}{2\pi \times f_{zMOD} \times R_C}$$

As the load current decreases, the modulator pole also decreases; however, the modulator gain increases accordingly and the crossover frequency remains the same. For the case where f_{zMOD} is less than f_C :

The power-modulator gain at f_C is:

$$GAIN_{MOD}(f_C) = GAIN_{MOD}(dc) \times \frac{f_{pMOD}}{f_{zMOD}}$$

The error-amplifier gain at f_C is:

$$GAIN_{EA}(f_C) = g_{m,EA} \times R_C \times \frac{f_{zMOD}}{f_C}$$

Therefore:

$$GAIN_{MOD}(f_C) \times \frac{V_{FB}}{V_{OUT}} \times g_{m,EA} \times R_C \times \frac{f_{zMOD}}{f_C} = 1$$

Solving for R_C :

$$R_C = \frac{V_{OUT} \times f_C}{g_{m,EA} \times V_{FB} \times GAIN_{MOD}(f_C) \times f_{zMOD}}$$

Set the error-amplifier compensation zero formed by R_C and C_C at the f_{pMOD} ($f_{zEA} = f_{pMOD}$).

$$C_C = \frac{1}{2\pi \times f_{pMOD} \times R_C}$$

If f_{zMOD} is less than $5 \times f_C$, add a second capacitor C_F from COMP to AGND. Set $f_{pEA} = f_{zMOD}$ and calculate C_F as follows:

$$C_F = \frac{1}{2\pi \times f_{zMOD} \times R_C}$$

PCB Layout Guidelines

Careful PCB layout is critical to achieve low switching losses and clean, stable operation. Use a multilayer board whenever possible for better noise immunity and power dissipation. Follow these guidelines for good PC board layout:

- 1) Use a large contiguous copper plane under the device package. Ensure that all heat-dissipating components have adequate cooling. The bottom pad of the devices must be soldered down to this copper plane for effective heat dissipation and getting the full power out of the devices. Use multiple vias or a single large via in this plane for heat dissipation
- 2) Isolate the power components and high current path from the sensitive analog circuitry. This is essential to prevent any noise coupling into the analog signals.
- 3) Keep the high-current paths short, especially at the PGND terminals. This practice is essential for stable, jitter-free operation. The high current path comprising of input capacitor, high-side FET, inductor, and the output capacitor should be as short as possible.
- 4) Keep the power traces and load connections short. This practice is essential for high efficiency. Use thick copper PCBs (2oz vs. 1oz) to enhance full-load efficiency.
- 5) The analog signal lines should be routed away from the high-frequency planes. This ensures integrity of sensitive signals feeding back into the IC.
- 6) The ground connection for the AGND and PGND section should be close to the IC. This keeps the ground current loops to a minimum. In cases where only one ground is used, adequate isolation between analog return signals and high-power signals must be maintained.

Ordering Information

PART	V _{OUT} ADJUSTABLE (FB TIED TO RESISTOR DIVIDER)	V _{OUT} FIXED (FB TIED TO BIAS)	MAX OPERATING CURRENT	TEMP TANGE	PIN-PACKAGE
MAX17242 ETPA+	1V TO 10V	5V	2A	-40°C to +85°C	20 TQFN-EP*
MAX17242ETPB+	1V TO 10V	3.3V	2A	-40°C to +85°C	20 TQFN-EP*
MAX17243 ETPA+	1V TO 10V	5V	3A	-40°C to +85°C	20 TQFN-EP*
MAX17243ETPB+	1V TO 10V	3.3V	3A	-40°C to +85°C	20 TQFN-EP*

+Denotes a lead(Pb)-free/RoHS-compliant package.

*EP = Exposed pad.

Chip Information

PROCESS: BiCMOS

Package Information

For the latest package outline information and land patterns (footprints), go to www.maximintegrated.com/packages. Note that a "+", "#", or "-" in the package code indicates RoHS status only. Package drawings may show a different suffix character, but the drawing pertains to the package regardless of RoHS status.

PACKAGE TYPE	PACKAGE CODE	OUTLINE NO.	LAND PATTERN NO.
20 TQFN-EP	T2055+4C	21-0140	90-0010

MAX17242/MAX17243

3.5V–36V, 2A/3A, Synchronous Buck Converter
with 15 μ A Quiescent Current and Reduced EMI

Revision History

REVISION NUMBER	REVISION DATE	DESCRIPTION	PAGES CHANGED
0	10/15	Initial release	—

For pricing, delivery, and ordering information, please contact Maxim Direct at 1-888-629-4642, or visit Maxim Integrated's website at www.maximintegrated.com.

Maxim Integrated cannot assume responsibility for use of any circuitry other than circuitry entirely embodied in a Maxim Integrated product. No circuit patent licenses are implied. Maxim Integrated reserves the right to change the circuitry and specifications without notice at any time. The parametric values (min and max limits) shown in the Electrical Characteristics table are guaranteed. Other parametric values quoted in this data sheet are provided for guidance.

Mouser Electronics

Authorized Distributor

Click to View Pricing, Inventory, Delivery & Lifecycle Information:

[Maxim Integrated:](#)

[MAX17243ETPB+](#) [MAX17242ETPB+](#)